



Users Manual

JUMBO JR.

Symphony

AIR COOLER

Identification of parts

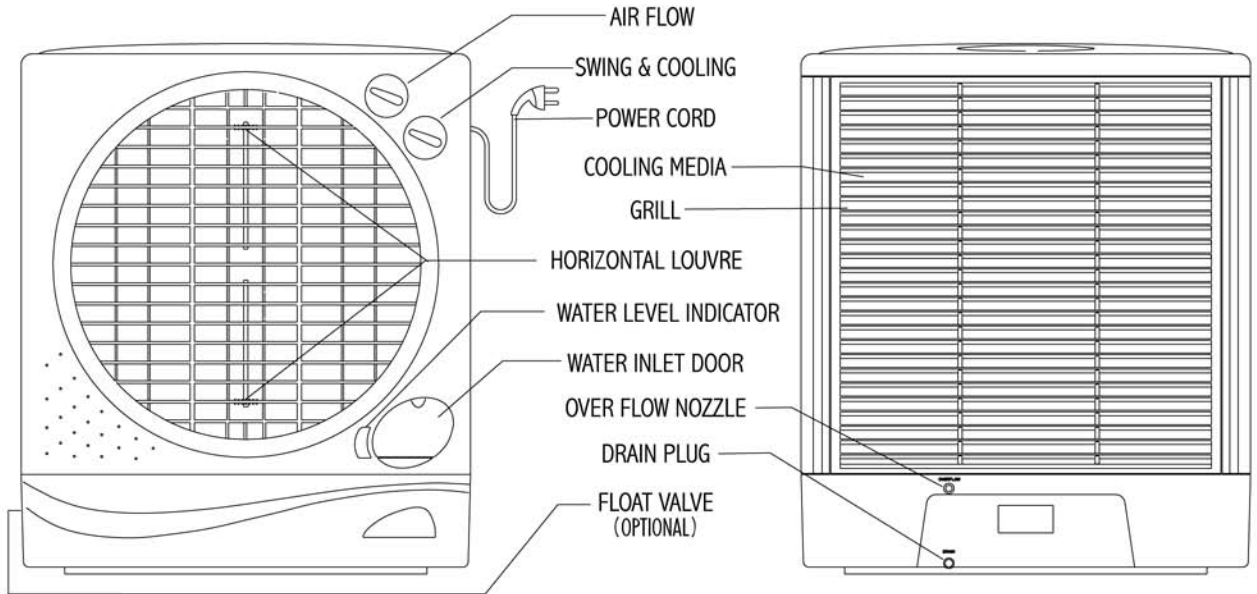

Technical Specifications

Model and Type - Jumbo jr.
 Net Size of body (mm) - 520L x 446B x 612H
 Water Capacity - 22 ltr.
 Rated Current (AMP) - 1.7 max.
 Cooling Area (Approx.) - 35 sq.m./350 sq.ft.
 Nominal Air Capacity - 2200m³/hr

Electrical Rating

Electrical Rating				
Rated Voltage	Volts	220 - 240	220 - 240	110 - 127
Rated Frequency	Hz	50	60	60
Motor Speed	RPM	1400	1400	1400
Rated Power (Max.)	Watts	100	160	

How to get started

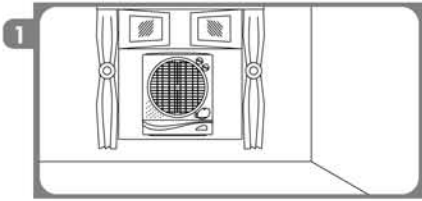

1 Install the cooler in window for effective cooling. It can also be placed on trolley. Do not use in a closed room.

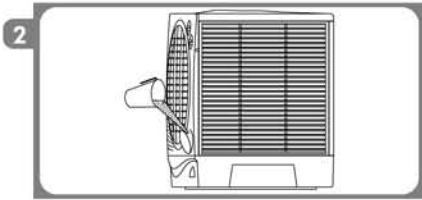

2 Pour water by pulling the water inlet door at the front. Check the water level by water level indicator.

Or

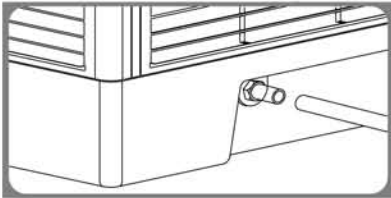

Connect a pipe to the float valve (optional) for continuous supply of water.

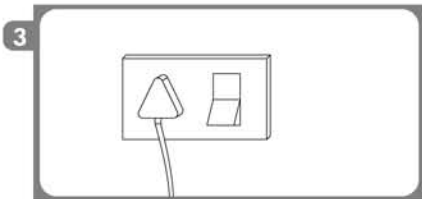

3 Plug in to 5A power source & switch on.

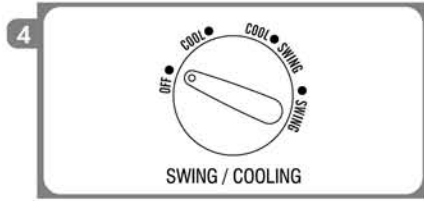

4 Cooling: The pump is on. Ensures cool air.
 Swing & Cooling: The pump is on. Vertical swing of air is active.
 Swing: The pump is off. Vertical swing of air is active.



5 Wait for 5 minutes, for the pads to get wet properly.

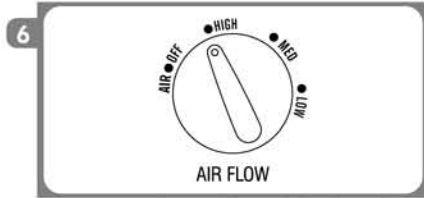

6 For maximum cooling turn the Air Flow knob to High.

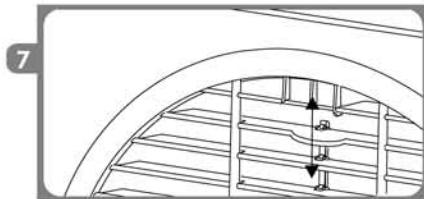

7 Adjust louver for air movement in horizontal direction.



8 Sit back and enjoy.

Trouble shooting

Trouble	Cause	Remedy	
1	Excessive cooling	Air flow control knob on 'High' mode	Reduce the speed.
		Excessive wetting of pads	Turn OFF the pump.
2	Less cooling	Pump is switched OFF	Switch ON the pump.
3	Water leakage	Drain plug is displaced	Ensure that Drain Plug (in the bottom of the cooler towards the front) is positioned properly.
		Grill is dislocated	Relocate the grill
		Unit is moved after the tank is filled	Ensure that you move the cooler only when water tank is empty.
		Cooling pad sagging	Change the cooling pads.
4	Fan not working	Air Flow switch is turned OFF	Switch ON the fan by selecting the required speed.
		Loose contact at the socket	Rectify faulty wiring.
		Switch or Motor is defective	Call the nearest service provider.
5	Shock on cooler	Leakage between phase and earth	Rectify faulty wiring.
			Call the nearest service provider.

General Instructions:

- While filling water, watch the water level indicator given in front of the cooler.
- Do not overfill the tank.
- Do not move the cooler while the tank is full or when the cooler is on.
- Switch on the pump at least 5 minutes before switching on the fan for effective cooling & better performance.
- If the supply cord is damaged, it must be replaced by the manufacturer or its service agent or a similarly qualified person in order to avoid a hazard.

Maintenance Instructions:

- Empty the water tank by removing the drain plug.
- Open the side panels to dry up the cooling pads.
- Clean the interiors of the cooler with a dry cloth.
- Oil the motor and pump (preferably SAE 40 grade oil) from the oiling points provided to avoid jamming when not in use.
- While using next time follow the general instructions.
- It is advisable to change the cooling pads every year for better performance of the cooler.
- For genuine Symphony spare parts, contact the nearest authorised service provider.

Please get in touch with the nearest authorised Symphony service centre for fixing any cooler problem.

Wiring diagram

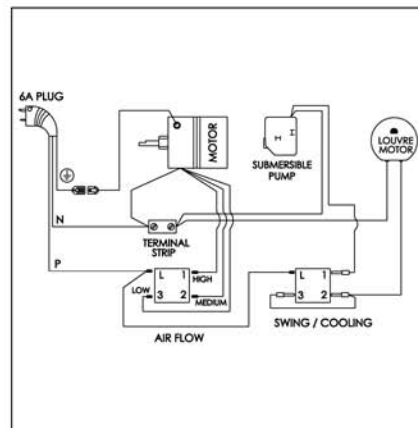

JUMBO[®] JR. WARRANTY REGISTRATION CARD (Valid in India only)

Name: _____

Address: _____

E-mail _____ Phone No.[R] _____ [Mobile] _____

Date of Purchase _____ Bill No. _____ Purchase Price Rs. _____

Machine Serial No.

Symphony
Service Centre Phone No.:

DEALER STAMP & SIGN

Conditions of Warranty (Valid in India only)

1) We extend this limited warranty to the original buyer (first retail purchaser) and warrant that the product "SYMPHONY" shall be free from original defects in workmanship and materials for 12 months from the date of purchase. 2) Warranty is deemed to come into effect when the following conditions are completed: a) Warranty registration card duly filled received within 15 days from the date of purchase. b) Product is inspected and operations explained to you by our Authorised Service Provider (ASP) / Dealer / Distributor. 3) The company's liability under the warranty will be limited only to motor, pump & louvers motors and also restricted to any such defect which occurs under conditions of normal operations and under proper use. Any part/s replaced by the company at its discretion shall be with a functionally operative unit. 4) This warranty shall not apply to product A. Which have not been purchased from authorised SYMPHONY distributor through their network or company's authorised retail outlets. B. Which have been altered / repaired / opened by any other than SYMPHONY ASP. C. Incorrectly used in combination with any other substance or products. D. Which are used for commercial purpose. E. Which develop defects due to faulty care or maintenance and alterations to product or its parts. F. Which is subjected to electrical supply for which the product is not designed? 5) For units installed beyond the municipal limits of towns and cities covered by the authorised service partners/dealer network, all expenses incurred in deputising of service personnel / technicians towards conveyance and other incidentals etc. will be borne by the customer. 6) While the company will make every effort to carry out the repairs at the earliest, it however is made expressly clear that the company is under no obligation to do so in a specified period of time. 7) This warranty shall automatically terminate on the expiry of the warranty period of 12 months from the date of purchase even if the product may not be used for any time during the warranty period for any reason whatsoever. 8) External plastic parts are not covered by any warranty. 9) The company shall not be liable in any case for any loss or damage caused to any property, death or disability caused to any human life arising out of fire, electrical fault, short circuit, accidental handling or any kind of natural calamity. As such the company's liability is limited to the cost of the spare parts of the said products only. 10) Change of the address of the customer must be intimated to the company without which the warranty shall not be operational. 11) Due to ongoing research and development, the company holds the right to modify the product without any prior notice or obligation to buyers. 12) Purchaser should retain the purchase bill as evidence of the date of purchase. 13) During the warranty customer is not entitled for any exchange of product or refund of money. 14) Service for this product shall be provided at customer's premises in India only. 15) The courts / Consumer Forum at Ahmedabad, Gujarat, India only shall have exclusive jurisdiction for any disputes arising out of this sale / transactions. Warranty outside India to be given by the local country distributor only.

Register warranty by sending a photocopy of warranty card along with copy of purchase bill.



www.symphonycomfort.com

Symphony comfort systems ltd.
'Sanskrut', Old High Court Road, Ahmedabad-9 INDIA